

DS-600 Setup Guide

English
silex
technology



Thank you for purchasing the USB Device Server "DS-600". This Setup Guide provides information on how to configure and use the DS-600 in your network.

Package Contents

- DS-600
- AC adaptor
- Warranty Booklet
- Setup Guide (this document)

Name of Parts

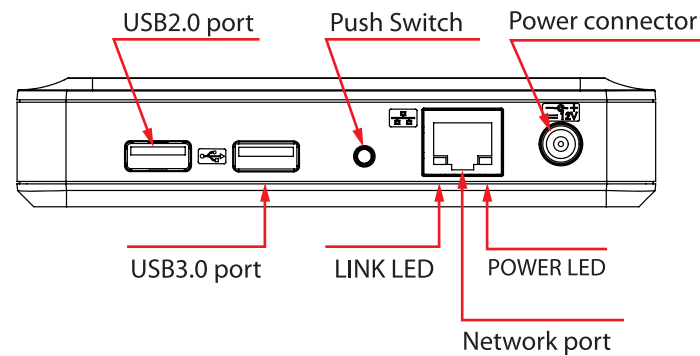

Setup Flow

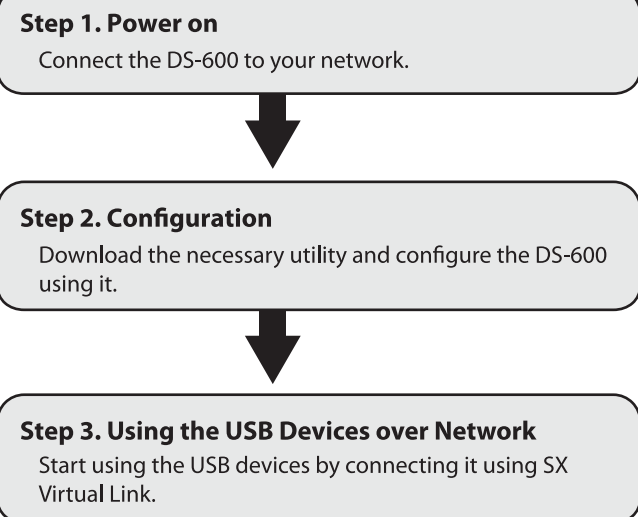

Step 1. Power on

How to power on the DS-600 is explained:

- 1** The following items are required.

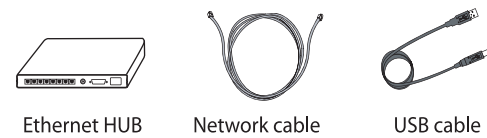

* If the DS-600 has been used in another network, reset it to factory default first (see below for details).

- 3** Connect the DS-600 to the USB device using a USB cable (2).

* There are USB devices not supported due to the driver specification. Please check the latest compatibility information on our website.
* Only 1 device can run on bus power.

- 4** Connect the AC adaptor to the DS-600 (3) and the AC plug to the power outlet (4). Check that POWER LED and LINK LED turn on (5).

* Be sure to use the AC adaptor that came with the DS-600.

- 2** Connect the DS-600 to the Ethernet HUB using a network cable (1).

- 5** If the USB device requires external power, use the power supply cable (6).

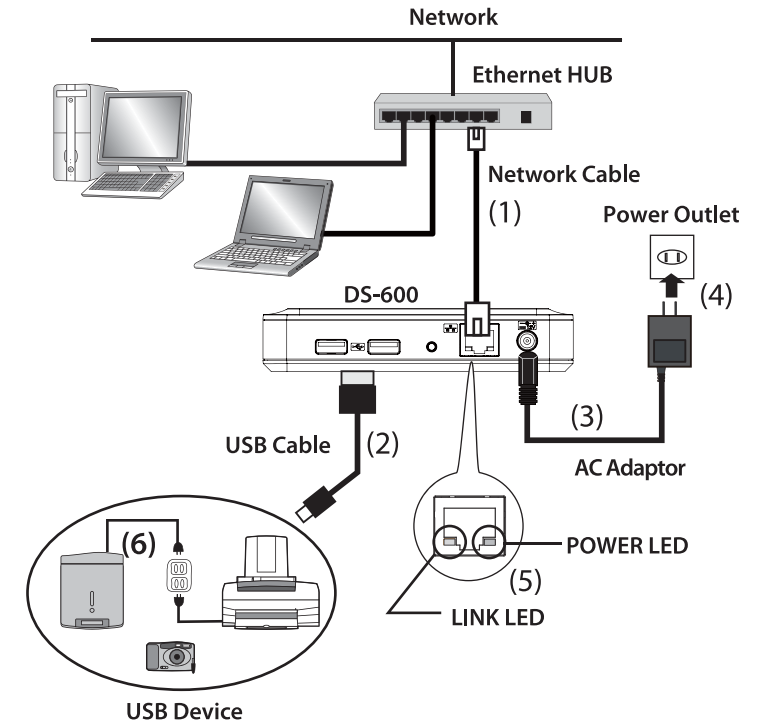

Factory Default Configuration

- 1** Remove the AC plug from the power outlet (1).
- 2** Push and hold the push switch with a fine tipped object such as a pen or pencil while inserting the AC plug back into the power outlet (2). Continue holding.
- 3** When the LINK LED (Orange) turns on (3), the factory default configuration is complete. Release the push switch.

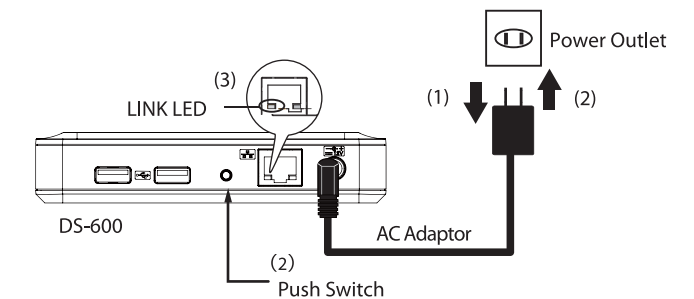

Step 2. Configuration

2-1. Downloading the Necessary Items

This section explains how to download the necessary utilities and user's manual from our website.

- 1** Access the URL below from the computer you are using to configure the DS-600.

USA : silex technology america, Inc.
URL : <http://www.silexamerica.com/>

Europe : silex technology europe GmbH
URL : <http://www.silexeurope.com/>

- 2** Go to the **Support** page and select the product model.

Product Model	DS-600
---------------	--------

- 3** Download the utilities and documents below to your computer.

Utility	Device Server Setup
	SX Virtual Link
User's Manual	DS-600 User's Manual
	Device Server Configuration guide
	SX Virtual Link Installation guide

2-2. Configuration

How to configure the DS-600 is explained:

By default, the DS-600 is configured to automatically obtain an IP address from the DHCP server. If the DHCP server is installed on your network, the configuration will not be necessary. In such a case, go on to install the SX Virtual Link (see the back).

When you want to configure the IP address manually or you are not sure if there is the DHCP server on your network, move on to **1**.

* Before moving on to **1**, please temporarily disable the firewall function of the computer you use for configuration. Some of the methods to disable the firewall are provided in the FAQ on our homepage.
- Commercial security software's firewall function

- 1** Extract the Device Server Setup file that you have downloaded at **2-1. Downloading the Necessary Items**.

- 2** Configure the DS-600 using **Device Server Setup** utility according to instructions on **Device Server Configuration** guide (PDF file).

The SX Virtual Link is the software program to make a communication between your computer and the USB devices connected to the device server.
To use the USB devices over the network, you have to connect to or disconnect from it using the SX Virtual Link.

If the SX Virtual Link is not installed to your computer, install it by following the instructions in this section.

Extract the SX Virtual Link file that you have downloaded at **2-1. Downloading t**

Starting the SX Virtual Link

Click the application icon (🔌) in the task tray or click **Start - (All) Programs - SX Virtual Link - SX Virtual Link**.

Connecting the USB devices

To install the driver, refer to the operating manual that came with the USB device, or follow the instructions on the screen displayed after clicking the **Connect** button in the SX Virtual Link.

Select a USB device and click the **Connect** button (🔌). The USB device can be connected when the status icon [🟢] is displayed.

- * The USB device can also be connected by selecting and double-clicking it on the SX Virtual Link.
- * If a device server is not displayed on a list, please click the **Refresh** button (🔄).
- * Do not unplug the USB cable or network cable, or click the **Disconnect** button (🔌) on the SX Virtual Link while the USB device is in use.

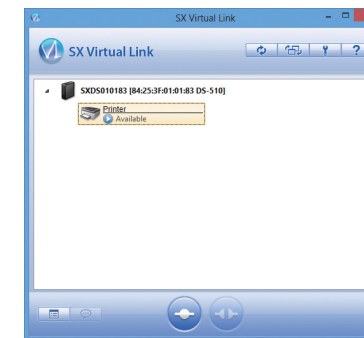

The Plug and Play function automatically creates an appropriate environment to use the selected device.

The USB device will be ready to use once the status icon has changed to [🟢]. See the operating manual that came with your USB device for how to use it.

Disconnecting the USB devices

When you have finished using the USB device, disconnect the device by selecting it and clicking the **Disconnect** button (🔌).

* The USB device can also be disconnected by selecting and double-clicking it on the SX Virtual Link.

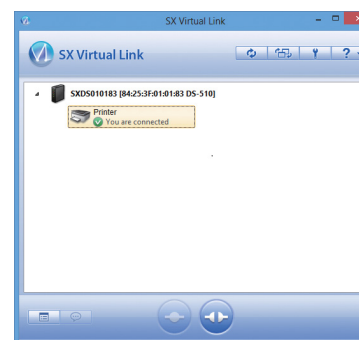

Accessing Online Help

